

# system 3R

## Starter-Set Unizero Go!

### UNIMATIC

Clamping  
System for  
Wire EDM



Benefit from all advantages  
of UNIMATIC - immediately

- ✓ Rugged, stable clamping of workpieces
- ✓ High repetitive accuracy on pallet changes
- ✓ Accurate adjustment of workpieces
- ✓ Setting up the Z height of workpieces
- ✓ Simple handling

system 3R

---

# S 112 050 Set Unizero Go!

consisting of:

- 1x C 950 000  
Chuck
- 1x C 950 170  
Unizero adjusting pallet
- 1x C 960 110  
Unimatic vice 10-30
- 1x C 190 820  
Air-pistol valve
- 1x E 100 007  
Set hexagon allen wrench
- 1x C 950 020  
Unimatic brackets universal

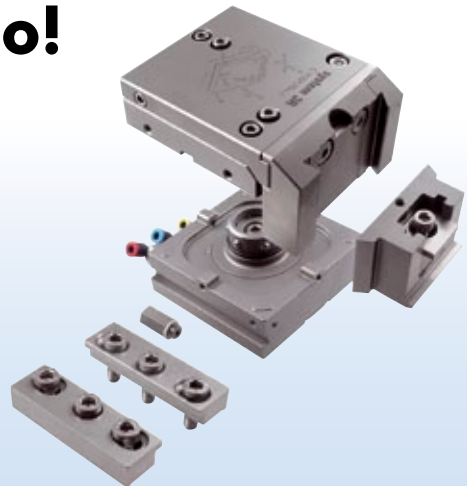

Technical data see WEDM catalogue

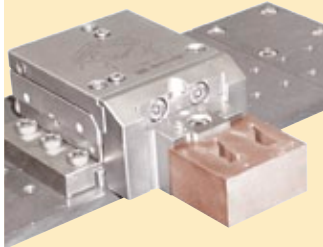

  
**Quick  
installation  
on each  
machine table**

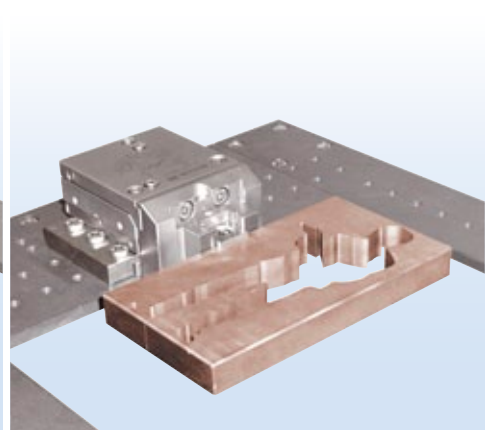
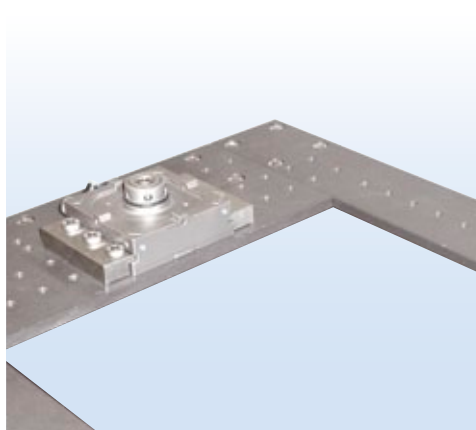

  
**Simple  
handling  
using air-  
pistol valve**

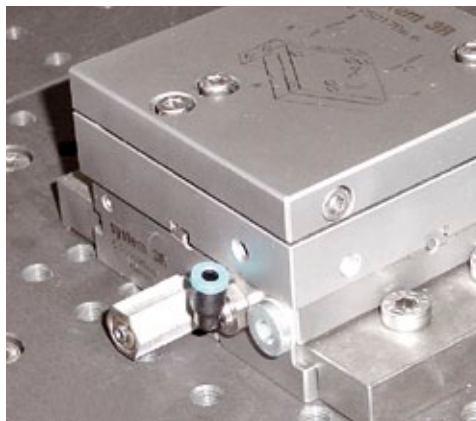

Air-pistol valve  
C 190 820



  
**Anytime  
expandable,  
also for  
automated  
applications**

Unimatic control unit (simple)  
(option, instead of air-pistol valve)  
C 960 500



Unimatic vice 0-175  
(option)  
C 960 180

